

Item	Description and Specifications	Additional Dimensions	Photos
Loop Legs			
Loop legs require a main desk beam when installing with PLT tops.			
PLTLEG-LP-24SILVER	Loop leg for 24" deep top, silver	24" wide x 28 1/2" high	
PLTLEG-LP-30SILVER	Loop leg for 30" deep top, silver	30" wide x 28 1/2" high	
	<i>Comes with bracket</i>		
U Legs 28" high			
U Legs require a main desk beam when installing with PLT tops.			
PLTLEG-U-24SILVER	U Leg for 24" deep top, silver	24" wide x 28 1/2" high	
PLTLEG-U-30SILVER	U Leg for 30" deep top, silver	30" wide x 28 1/2" high	
PLTLEG-U-36SILVER	U Leg for 36" deep top, silver	36" wide x 28 1/2" high	
	<i>36" ships with 1 PLT-CBB bracket</i>		
PLTLEG-U-48SILVER 1/2	U Leg for 48" deep tops, silver,	48" wide x 28 1/2" high	
PLTLEG-U-60SILVER 1/2	U Leg for 60" deep tops, silver	60" wide x 28 1/2" high	
	<i>48" and 60" U Legs require PLT-CBB bracket</i>		
Metal End Panels for U Legs For use with 28" high U Legs			
Decorative metal end panel for use with U-legs for extra privacy and modern design.			
PLTULEG-FMEPP24SILVER	28" high metal end panel for U leg 24, silver	for use with 24" wide U leg	
PLTULEG-FMEPP30SILVER	28" high metal end panel for U leg 30, silver	for use with 30" wide U leg	
PLTULEG-FMEPP48SILVER	28" high metal end panel for U leg 48, silver	for use with 48" wide U leg	
PLTULEG-FMEPP60SILVER	28" high metal end panel for U leg 60, silver	for use with 60" wide U leg	
Support U Legs			
PLT-LEG U 4860 ILSILV	Inset U leg for 48" and 60" deep tops. 16" leg spread. Requires 2 PLT-MBMBC through beams.	28 1/2" high x 35" wide 5" deep	
PLT-LEG U 4860 ILCMB Silver	Inset U leg with Cover 48/60	For use with 28" high U legs	
PLT-LEG-U-4860ILCMBBLACK	48"/60" INSET U LEG W/CVR+MB-B		<p><i>Also available in black</i></p>
	<i>PLT-LEG U 4860ILCMB Silver and Black ship with 2 PLT-MBMBC through beam connectors</i>		
	<i>Use BLACK PLT-LEG-U-4860ILCMB with BEVEL legs.</i>		
Square Post Legs			
PLT-SQPOSTLEGPAAIR Silver	Silver PAIR of Square Offset post legs		<p><i>Shown above with support stiffeners- PLT-60MS or</i></p>
PLT-SQPOSTLEGPAAIRBLACK	SQUARE POST LEG-BLACK-PAIR		
U Legs- Standing Height 41" high			
U Legs may require main desk beams and PLT-CBB silver set when installing with PLT tops.			
<i>PLT-CBB silver set connects main desk beam to legs.</i>			
PLTLEG-U-24NB41H-SILVER	41" high U Leg for 24" deep top, silver	24" wide x 41" high	
PLTLEG-U-30NB41H-SILVER	41" high U Leg for 30" deep top, silver	30" wide x 41" high	
PLTLEG-U-48NB41H-SILVER	41" high U Leg for 48" deep top, silver	48" wide x 41" high	
PLTLEG-U-60NB41H-SILVER	41" high U Leg for 60" deep top, silver	60" wide x 41" high	
PLTLEG-U-4860ILCMB41HSILVER	41"H INSET LEG (W/COVER)SILVER	For use with 41" high U legs	
	<i>Standing height inset leg. Ships with 2 MBMBC through beam connectors</i>		

VA LEG, Leg and Mounting Bracket separate

Top Mounting Plates (All VA legs require a top mounting plate)

PLTVALEGMOUNT2430 Silver
PLTVALEGMOUNT2430BLACK

VA leg top MT Plate 24/30 Silver
VA LEG TOP MT PLATE 24X30-BLK
For use with 24" or 30" deep worksurfaces

Use to mount VA legs to the underside of worksurface. VA legs and mounting plate sold separately.

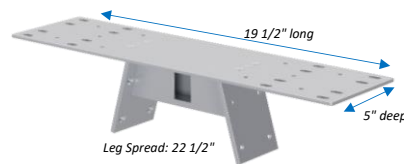

Available in silver and black



PLTVALEGMOUNT3642SILVER
PLTVALEGMOUNT3642BLACK

VA LEGMOUNT MT PLATE 36X42 Silver
VA LEG TOP MT PLATE 36X42-BLK
For use with 36" or 42" deep worksurfaces
Has 3 holes

Use to mount VA legs to the underside of worksurface. VA legs and mounting plate sold separately.

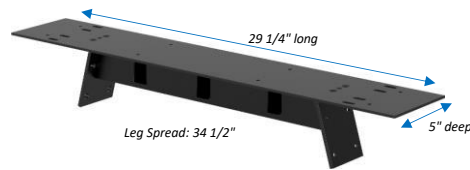

Available in silver and black



PLTVALEGMOUNT4860BLACK
PLTVALEGMOUNT4860SILVER

VA LEG MT PLATE 48X60-BLK
VA LEG TOP MT PLATE 48X60-BLK
For use with 48" or 60" deep worksurfaces

Use to mount VA legs to the underside of worksurface. VA legs and mounting plate sold separately.

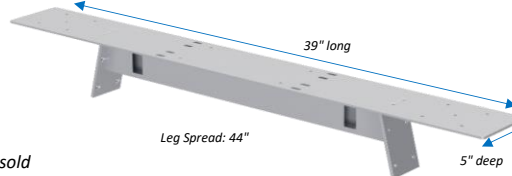

Available in silver and black



VA Legs (Sold in Pairs)

PLTVAMETLEG SILVER
PLTVAMETLEGBLACK
PLT-VARWLEGMW
PLT-VARWLEGNPG
PLT-VAWLEGNO

VA Metal leg pair Silver
VA METAL LEG PAIR-BLK
VA Walnut wood leg Pair 28 1/2"H
VA NPG wood leg Pair 28 1/2"
VA Nat Oak wood leg Pair 28 1/2"

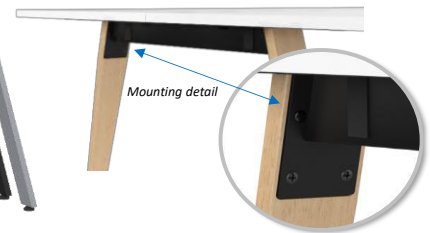

Power Wood VA Leg (sold individually)

PLT-ECVARWLEGMW
PLT-ECVARWLEGNO
PLT-ECVARWLEGNPG

Power wood Leg-Modern Walnut
Power wood leg-Natural oak
Power wood leg Newport Grey

Sold individually. Use with PLTVALEGMOUNT to attach to underside of worksurface.



Signature Metal Tall Legs (sold in pairs)

PLTVALEG41 SILVER
PLTVALEG41 BLACK

Tall Metal VA Leg 41" H Silver
Tall Metal VA Leg 41" H Black
Use with PLTVALEGMOUNT to attach to underside of worksurface.
Cross brace required



VA Tall Leg Cross Brace

PLTVA243041CB SILVER
PLTVA243041CB BLACK

Cross Brace for 2430 41" VA Leg
Cross Brace for 2430 41" VA Leg
Required for use with tall metal legs
Additional lower main desk beam may be required if creating tall stand alone worksurface.

Desk Risers

PLTDR2430-SILVER
PLTDR2430-BLACK

24/30" DEEP DESK RISER- Silver
24/30" DEEP DESK RISER-Black

Use when installing 24" or 30" deep worksurface on PL1012 or PL1013 with no feet. This desk riser will allow for standard work surface height.

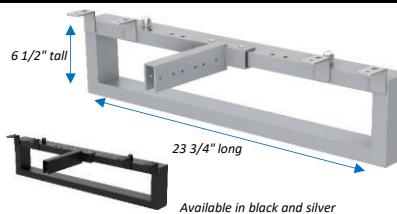

Hutch Supports and Hutch Support Glides

Hutch supports are sold in pairs

PLT-LP HS20 Silver
 PLT-LPHS20 Black

20" high loop hutch support, pair, silver
 20" high loop hutch support, pair, black

Available in silver or black



PLT-LPHS27Black
 PLT-LP HS27 Silver
 PLT-LP HS Glide A2

27" high loop hutch support, pair, black
 27" high loop hutch support, pair, silver
 Glide for PLTLP-HS-27 A2(Set of 2)
 Use when installing 27" high supports on the floor



Available in silver or black



Support Pieces

13 3/4" wide

PLTLEG-U-HALFSILVER

Half U leg silver

Requires CBB Connector beam bracket

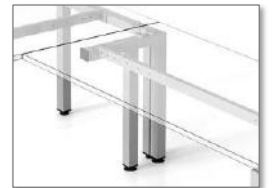
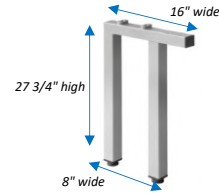

PLTMBMBCSILVER

Connector through bracket (set of 2)

Use to gang multiple worksurfaces together.
 Bracket passes through table legs to connect main desk beams on both sides.

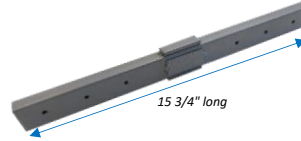

PLT-RETSUPPORTSILV

Return support bracket (single)

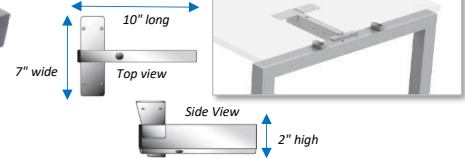

PLTCBBSILVER

Connector beam brackets (pair) for 48" & 60" legs.

For use when installing with main desk beams, return beams, and half legs.

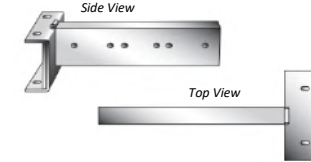

PLTFB

1 included with PLT U leg 30
 Flat Bracket



PLT-USUPPORTSILVER

U support bracket (Set of 2)

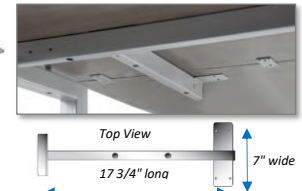
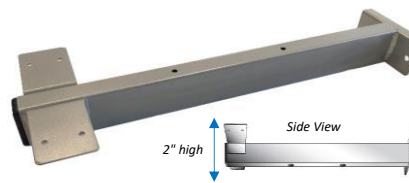

Main Desk Beams

Main desk beams required with Loop leg, U-leg, and VA leg. All beams 2" high x 1" deep. Not for use with beveled legs.

Adjustable main desk beams also available (see following page). Adjustable main desk beams required when using beveled legs

PLT-Maindeskbeam 48	For a 48" wide top	Actual length 43 3/8" long
PLT-Maindeskbeam 60	For a 60" wide top	Actual length 55 1/2" long
PLT-Maindeskbeam 66	For a 66" wide top	Actual length 61 1/2" long
PLT-Maindeskbeam 72	For a 72" wide top	Actual length 67 1/4" long



Return Beams
 Return beams include bracket. All beams 2" high x 1" deep. Not for use with beveled legs.
Adjustable return beams also available (see following page). Adjustable beams required when using beveled legs.



PLT-Return beam 48	For a 48" wide top	Actual length 56 5/16" long
PLT-Return beam 60	For a 60" wide top	Actual length 69 1/8" long
PLT-Return beam 66	For a 66" wide top	Actual length 75" long
PLT-Return beam 72	For a 72" wide top	Actual length 81 1/8" long



Lower Desk Riser

PLT-LDR2430 Black	Lower desk riser for 24" & 30" tops Black
PLT-LDR2430 Silver	Lower desk riser for 24" & 30" d tops Silver

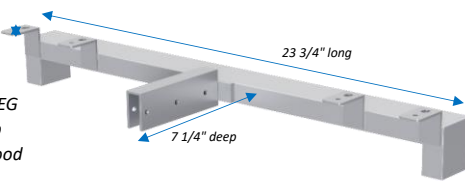
Use in combination with Cabinet Feet (PLT-AWRLEG or PLT-SMRLEG). When installing 24" or 30" deep worksurface on PL1012 or PL1013 with angled wood or small metal feet this desk riser will allow for a standard work surface height.

Available in black and silver

Cabinet Feet

PLT-AWRLEGMWN	Angled wood leg, small. Modern Walnut finish
PLT-AWRLEGNO	Angled wood leg, small. Natural wood finish
PLT-AWRLEGNPG	Angled wood leg, small. Newport Grey finish

Use in combination with PL1012 or PL1013. Feet require additional support blocks installed on underside of cabinet. Please see instructions for additional installation information.

Angled wood legs ship as a set of 4



Available in three finishes

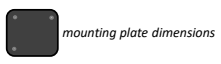

PLT-SMRLEG Black	2" X 2' X 4" H Black metal leg (Set of 4)
PLT-SMRLEG Silver	2' X 2" X 4" H Silver metal leg (Set of 4)

Use in combination with PL1012 or PL1013. Feet require additional support blocks installed on underside of cabinet. Please see instructions for additional installation information.

SMR legs ship as a set of 4

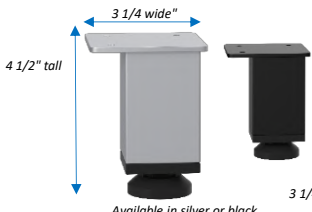



Available in silver or black



Bevel Loop Leg
 Bevel loop legs require a main desk beam and PLTBBSingle when installing with PLT tops.

PLTLEG-BEV24BLACK	Bevel Loop Leg for 24" deep top, black	24" wide x 28 1/2" high
PLTLEG-BEV30BLACK	Bevel Loop Leg for 30" deep top, black	30" wide x 28 1/2" high
PLTLEG-BEV48BLACK	Bevel Loop Leg for 48" deep top, black	48" wide x 28 1/2" high
PLTLEG-BEV60BLACK	Bevel Loop Leg for 60" deep top, black	60" wide x 28 1/2" high

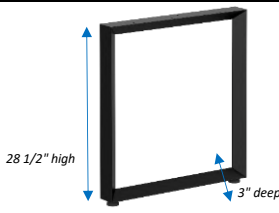
*PLTLEG-BEV24 and PLTLEG-BEV30 require 1 PLTBBSingle on each leg
 PLTLEG-BEV48 and PLTLEG-BEV60 require 2 PLTBBSingle on each leg*





Support Pieces for Bevel Loop Leg

PLT-BBBSINGLEBLACK	Connector beam bracket for Bevel loop leg (single)
PLT-RBBFPBLACK	Side Return Connector Beam Bracket with flat plate

Required on all Bevel loop legs.
 PLTLEG-BEV24 and PLTLEG-BEV30 require 1 on each leg
 PLTLEG-BEV48 and PLTLEG-BEV60 require 2 on each leg

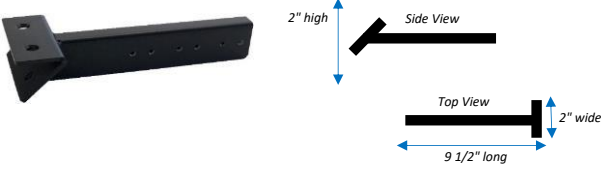
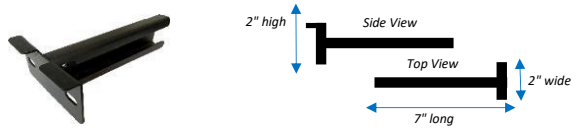
Required on all PLT-ADJRB6072

Adjustable Main Desk Beams
 Adjustable main desk beams required for beveled legs. All beams 2" high x 1" deep. Can also be used with loop leg, U-leg, and VA leg.

PLT- ADJMDB4872 Black	Adjustable main desk beam 48"-72"
------------------------------	-----------------------------------

For use with beveled legs and PLT tops. Can not be used with 48" or shorter PLT tops. Use PLTBBSUPPORTBLACK with shorter PLT tops. Adjustable beams are marked with measurements. When using with loop, U, and VA legs move beam in 1" shorter.

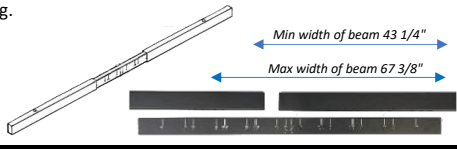

Adjustable Return Beams
 Adjustable return beams required for beveled legs. All beams 2" high x 1" deep. Can also be used with loop leg, U-leg, and VA leg.

PLT-ADJRB6072 Black	Adjustable return beam 60"-72"
----------------------------	--------------------------------

*Requires PLT-RBBFPBlack
 Adjustable beams are marked with measurements. When using with loop, U, and VA legs move beam in 1" shorter.*

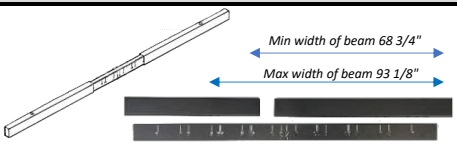

Side Tables

PLT-LTT-66TSILVER Laptop Table Frame for PL-66T, silver
 Use with PL-66T tops, sold separately

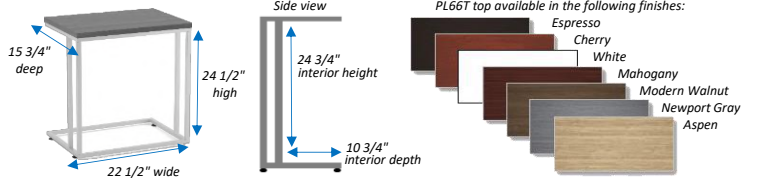

PLT-VLEGR Silver 28" metal V three leg table base, silver



PLTVLEG417SILVER METAL V LEG END TABLE BASE



PLTWMBASE2448BLACK ROD TABLE BASE 24X48"-BLK
PLTWMBASE3030BLACK ROD TABLE BASE 30"-BLK



Panel Mounting Brackets

Available in black or silver



Accessories

PLTPMD SILVER OR BLACK Personal metal drawer for Elements and Height Adjustable Tables
 When used with height adjustable bases, 30" deep tops required.

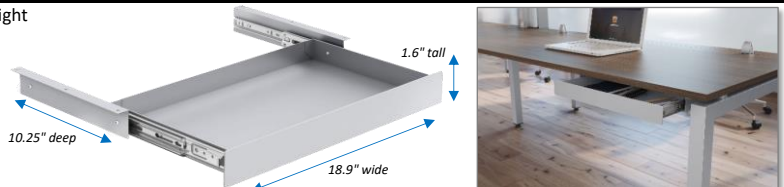

PLT-ATSilver Hanging accessory Tray- Silver
 Hangs over 3/4" fabric, acrylic, magnetic glass, or PB2 panel.

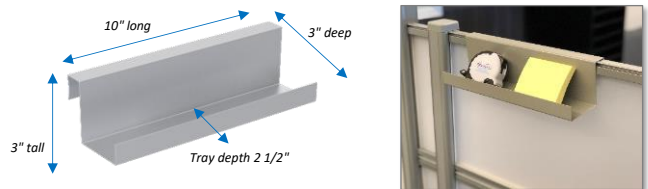

PLT-PHSilver Hanging pen holder- Silver
 Hangs over 3/4" fabric, acrylic, magnetic glass, or PB2 panel.

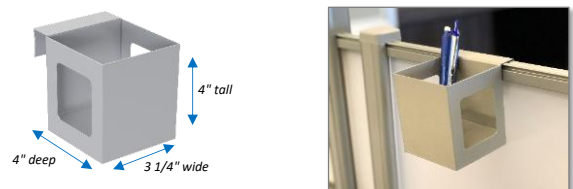

PLT-BHSILVER Table mount Bag hook
 Mounts to the edge of 1" thick worksurface. Padded with protective foam to prevent scratches.

